

Report on Electrical

Generated by MTT using :
(mtt -u -q -q Electrical rep pdf)

Tue Aug 19 14:47:25 BST 2003

Contents

I	Electrical	7
1	rc	9
1.1	rc_abg.tex	9
	1.1.1 Summary information	9
	1.1.2 Subsystems	12
1.2	rc_cbg.ps	12
1.3	rc_struc.tex	12
1.4	rc_sympar.txt	14
1.5	rc_ode.tex	14
1.6	rc_sm.tex	14
1.7	rc_tf.tex	15
1.8	rc_lmfr.ps	15
1.9	rc_simpar.txt	15
1.10	rc_numpar.txt	16
1.11	rc_input.txt	17
1.12	rc_odeso.ps	17
1.13	rc_input.txt (<i>-drstep</i>)	17
1.14	rc_odeso.ps (<i>-drstep</i>)	18
1.15	rc_input.txt (<i>-drpulse</i>)	18
1.16	rc_odeso.ps (<i>-drpulse</i>)	19
1.17	rc_numpar.txt (<i>-drstep -drr10</i>)	19
1.18	rc_input.txt (<i>-drstep -drr10</i>)	20
1.19	rc_odeso.ps (<i>-drstep -drr10</i>)	21
1.20	rc_numpar.txt (<i>-drpulse -drr10</i>)	21
1.21	rc_input.txt (<i>-drpulse -drr10</i>)	22
1.22	rc_odeso.ps (<i>-drpulse -drr10</i>)	22
1.23	rc_rep.txt	23
2	rc2	25
2.1	rc2_abg.tex	25
	2.1.1 Summary information	26

2.1.2	Subsystems	27
2.1.3	De	27
2.1.4	RC	29
2.1.5	Se	32
2.2	rc2_cbg.ps	34
2.3	rc2_struct.tex	34
2.4	rc2_sympar.tex	35
2.5	rc2_ode.tex	35
2.6	rc2_sm.tex	36
2.7	rc2_tf.tex	36
2.8	rc2_lmfr.ps	37
2.9	rc2_numpar.txt	37
2.10	rc2_odeso.ps	38
2.11	rc2_rep.txt	38

List of Figures

1.1	System rc : acausal bond graph	10
1.2	System rc , representation cbg (-noargs)	13
1.3	System rc , representation lmfr (-noargs)	15
1.4	System rc , representation odeso (-noargs)	18
1.5	System rc , representation odeso (-drstep)	19
1.6	System rc , representation odeso (-drpulse)	20
1.7	System rc , representation odeso (-drstep-drr10)	21
1.8	System rc , representation odeso (-drpulse-drr10)	23
2.1	System rc2 : acausal bond graph	25
2.2	System De : acausal bond graph	28
2.3	System RC : acausal bond graph	30
2.4	System Se : acausal bond graph	32
2.5	System rc2 , representation cbg (-noargs)	34
2.6	System rc2 , representation lmfr (-noargs)	37
2.7	System rc2 , representation odeso (-noargs)	38

Part I
Electrical

Chapter 1

rc

1.1 rc_abg.tex

MTT command:

```
mtt rc abg tex
```

The acausal bond graph of system **rc** is displayed in Figure 1.1 (on page 10) and its label file is listed in Section 1.1.1 (on page 9). The subsystems are listed in Section 1.1.2 (on page 12).

The system **rc** is the simple electrical rc circuit shown in Figure 1.1 (on page 10). It can be regarded as a single-input single-output system with input e_1 and output e_2 .

1.1.1 Summary information

System rc:a simple rc circuit A basic linear voltage-in voltage-out RC circuit
A standard test example for MTT

Interface information:

Parameter \$1 represents actual parameter **c**

Parameter \$2 represents actual parameter **r**

Variable declarations:

This component has no PAR declarations

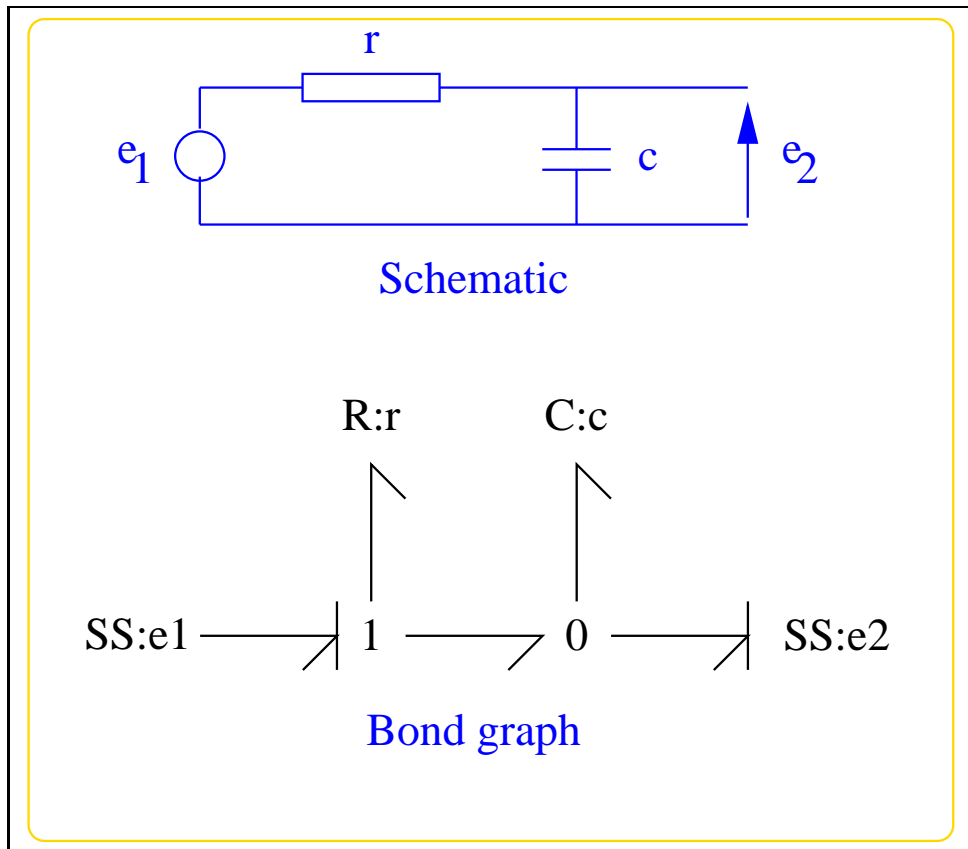

Figure 1.1: System **rc**: acausal bond graph

Units declarations:

This component has no UNITS declarations

The label file: rc_lbl.txt

```
## Label file for system rc (rc_lbl.txt)
#SUMMARY rc a simple rc circuit
#DESCRIPTION A basic linear voltage-in voltage-out RC circuit
#DESCRIPTION A standard test example for MTT

# #####
# ## Version control history
# #####
# ## $Id: rc_lbl.txt,v 1.2 2002/09/19 08:10:25 gawthrop Exp $
# ## $Log: rc_lbl.txt,v $
# ## Revision 1.2 2002/09/19 08:10:25 gawthrop
# ## Updated documentation documentation
# ##
# ## Revision 1.1 2000/12/28 17:40:36 peterg
# ## To RCS
# ##
# #####

# Port aliases

# Argument aliases
#ALIAS $1 c
#ALIAS $2 r

## Each line should be of one of the following forms:
#     a comment (ie starting with #)
#     component-name cr_name arg1,arg2,..argn
#     blank

# ---- Component labels ----
c lin effort,c

# Component type R
r lin flow,r
```

```
# Component type SS
e1 SS external,internal
e2 SS external,0
```

1.1.2 Subsystems

No subsystems.

1.2 rc_cbg.ps

MTT command:

```
mtt rc cbg ps
```

This representation is given as Figure 1.2 (on page 13).

1.3 rc_structex

MTT command:

```
mtt rc struc tex
```

List of inputs for system rc			
	Component	System	Repetition
1	e1	rc_e1	1

List of outputs for system rc			
	Component	System	Repetition
1	e2	rc_e2	1

List of states for system rc			
	Component	System	Repetition
1	c	rc_c	1

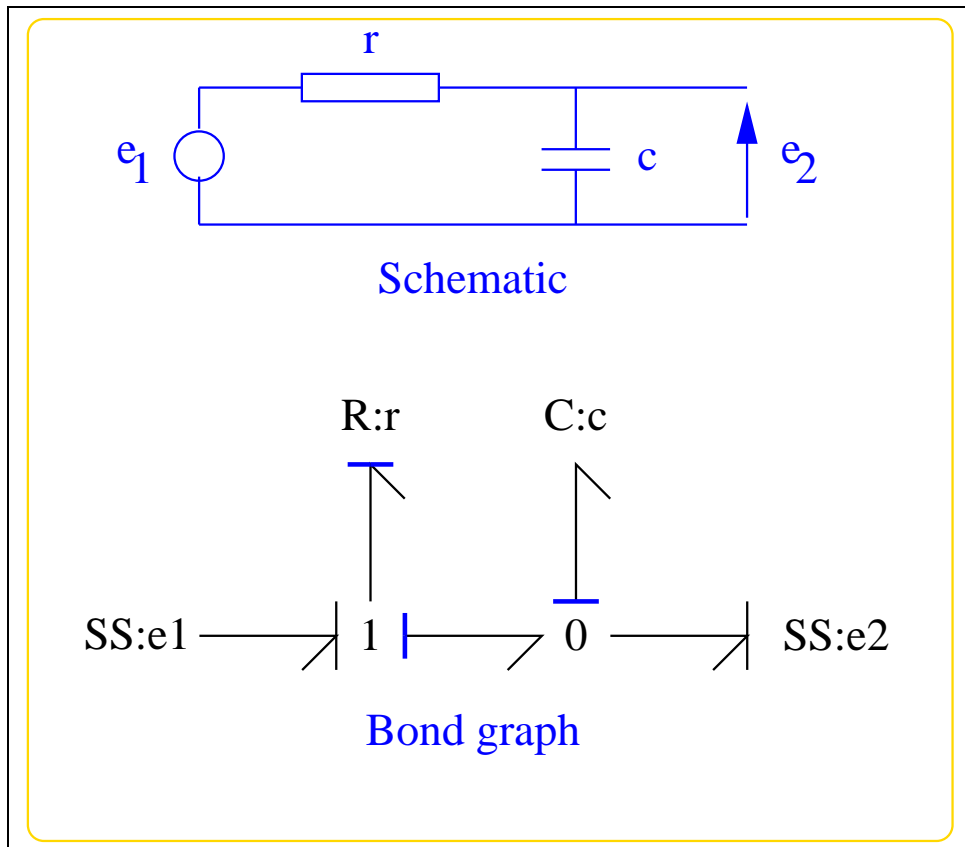

Figure 1.2: System **rc**, representation **cbg** (-noargs)

1.4 rc_sympar.txt

MTT command:

```
mtt rc sympar txt  
  
c rc  
r rc
```

1.5 rc_ode.tex

MTT command:

```
mtt rc ode tex
```

$$\dot{x}_1 = \frac{(cu_1 - x_1)}{(cr)} \quad (1.1)$$

$$y_1 = \frac{x_1}{c} \quad (1.2)$$

1.6 rc_sm.tex

MTT command:

```
mtt rc sm tex
```

$$A = \left(\frac{(-1)}{(cr)} \right) \quad (1.3)$$

$$B = \left(\frac{1}{r} \right) \quad (1.4)$$

$$C = \left(\frac{1}{c} \right) \quad (1.5)$$

$$D = (0) \quad (1.6)$$

1.7 rc_tf.tex

MTT command:

```
mtt rc tf tex
```

$$G = \left(\frac{1}{(crs+1)} \right) \quad (1.7)$$

1.8 rc_lmfr.ps

MTT command:

```
mtt rc lmfr ps
```

This representation is given as Figure 1.3 (on page 15).

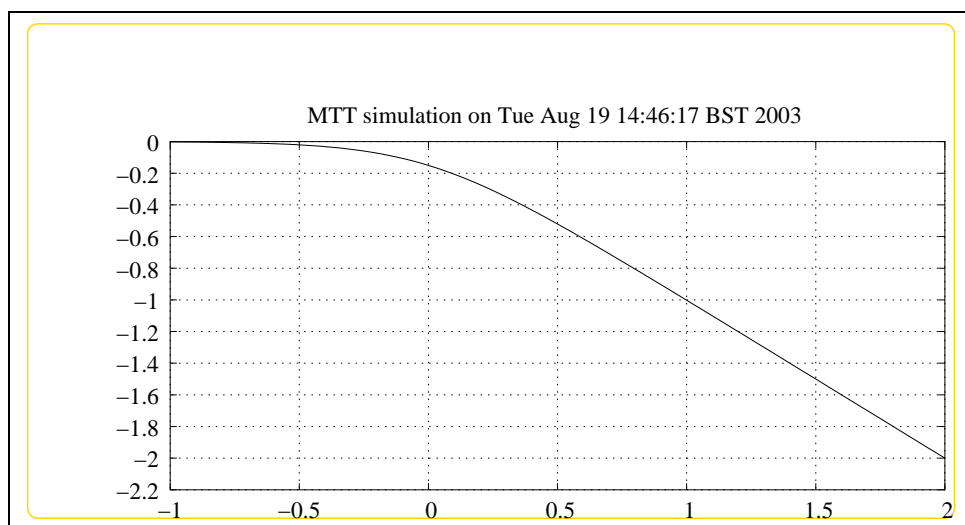

Figure 1.3: System **rc**, representation **lmfr** (-noargs)

1.9 rc_simpar.txt

MTT command:

```
mtt rc simpar txt
```

Tue Aug 19 14:47:25 BST 2003

Page 15.

```

# --octave-- Put Emacs into octave-mode
# Simulation parameters for system rc (rc_simpar.txt)
# Generated by MTT on Tue Aug 19 14:46:15 BST 2003.
#####
## Version control history
#####
## $Id: rcs_header.sh,v 1.1 2000/12/28 11:58:07 peterg Exp $
## $Log: rcs_header.sh,v $
## Revision 1.1 2000/12/28 11:58:07 peterg
## Put under RCS
##
#####

FIRST          = 0.0;          # First time in simulation output
DT              = 0.1;          # Print interval
LAST           = 10.0;         # Last time in simulation
STEPFACTOR     = 1;            # Integration steps per print interval
WMIN           = -1;           # Minimum frequency = 10^WMIN
WMAX           = 2;            # Maximum frequency = 10^WMAX
WSTEPS        = 100;           # Number of frequency steps
INPUT          = 1;            # Index of the input

```

1.10 rc_numpar.txt

MTT command:

```

mtt rc numpar txt

## --octave-- Put Emacs into octave-mode ##

##
## System rc, representation numpar, language txt;
## File rc_numpar.txt;
## Generated by MTT on Tue Aug 19 14:46:16 BST 2003;

c = 1.0; # Default
r = 1.0; # Default

```

1.11 rc_input.txt

MTT command:

```
mtt rc input txt

## -*-octave-* - Put Emacs into octave-mode ##

##
## System rc, representation input, language txt;
## File rc_input.txt;
## Generated by MTT on Tue Aug 19 14:46:19 BST 2003;

rc__e1 = 1.0; # Default
```

1.12 rc_odeso.ps

MTT command:

```
mtt rc odeso ps
```

This representation is given as Figure 1.4 (on page 18).

1.13 rc_input.txt (*-drstep*)

MTT command:

```
mtt -dr step rc input txt

## -*-octave-* - Put Emacs into octave-mode ##

##
## System rc, representation input, language txt;
## File rc_input.txt;
## Generated by MTT on Wed May 1 08:51:26 BST 2002;
```

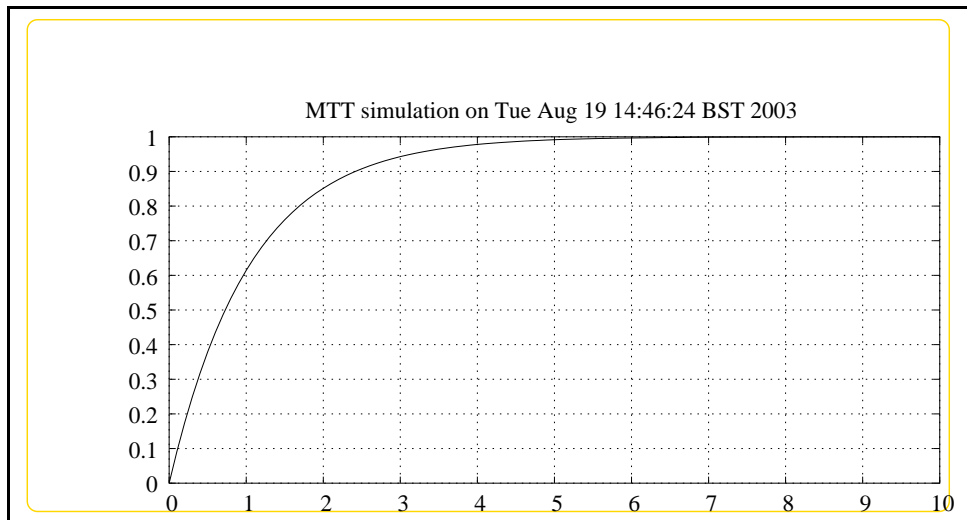

Figure 1.4: System **rc**, representation **odeso** (**-noargs**)

```
rc_e1 = 1.0; # Step
```

1.14 **rc_odeso.ps** (**-drstep**)

MTT command:

```
mtt -dr step rc odeso ps
```

This representation is given as Figure 1.5 (on page 19).

1.15 **rc_input.txt** (**-drpulse**)

MTT command:

```
mtt -dr pulse rc input txt
```

```
## --octave-- Put Emacs into octave-mode ##
```

```
##
```

Tue Aug 19 14:47:25 BST 2003

Page 18.

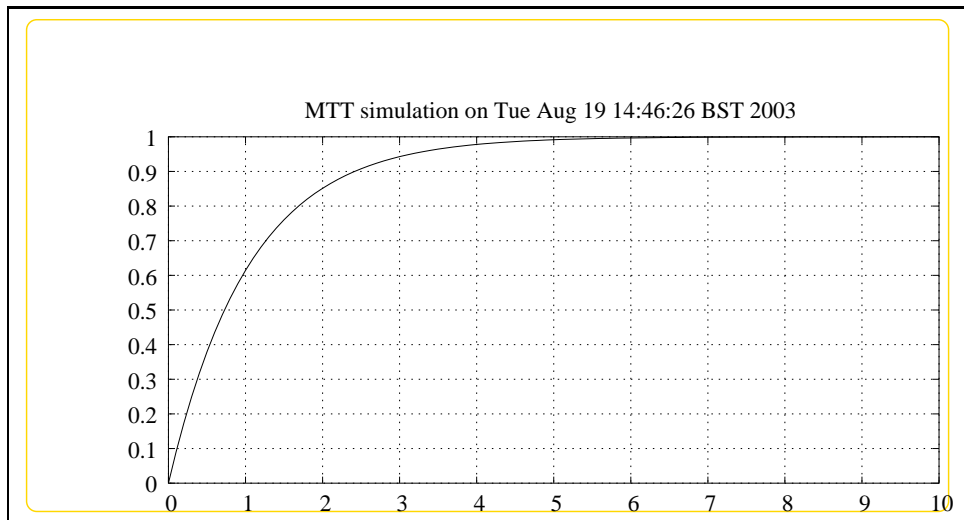
Figure 1.5: System **rc**, representation **odeso (-drstep)**

```
## System rc, representation input, language txt;
## File rc_input.txt;
## Generated by MTT on Wed May 1 08:47:22 BST 2002;
```

```
rc__e1 = 1.0*(t<1); # On for t<1
```

1.16 rc_odeso.ps (*-drpulse*)

MTT command:

```
mtt -dr pulse rc odeso ps
```

This representation is given as Figure 1.6 (on page 20).

1.17 rc_numpar.txt (*-drstep -drr10*)

MTT command:

```
mtt -dr step -dr r10 rc numpar txt
```

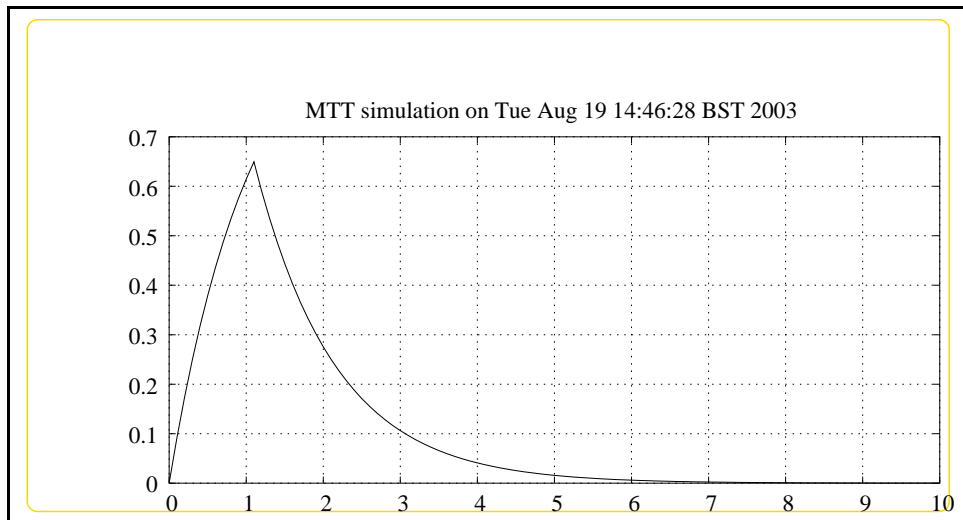
Figure 1.6: System **rc**, representation **odeso** (**-drpulse**)

```
## -*-octave-* - Put Emacs into octave-mode ##
##
## System rc, representation numpar, language txt;
## File rc_numpar.txt;
## Generated by MTT on Wed May 1 10:18:33 BST 2002;
```

```
c = 1.0; # c = 1 F
r = 10.0; # r = 10 ohms
```

1.18 rc_input.txt (**-drstep -drr10**)

MTT command:

```
mtt -dr step -dr r10 rc input txt
```

```
## -*-octave-* - Put Emacs into octave-mode ##
```

```
##
## System rc, representation input, language txt;
```

Tue Aug 19 14:47:25 BST 2003

Page 20.

```
## File rc_input.txt;  
## Generated by MTT on Wed May 1 08:51:26 BST 2002;
```

```
rc_e1 = 1.0; # Step
```

1.19 rc_odeso.ps (*-drstep -drr10*)

MTT command:

```
mtt -dr step -dr r10 rc odeso ps
```

This representation is given as Figure 1.7 (on page 21).

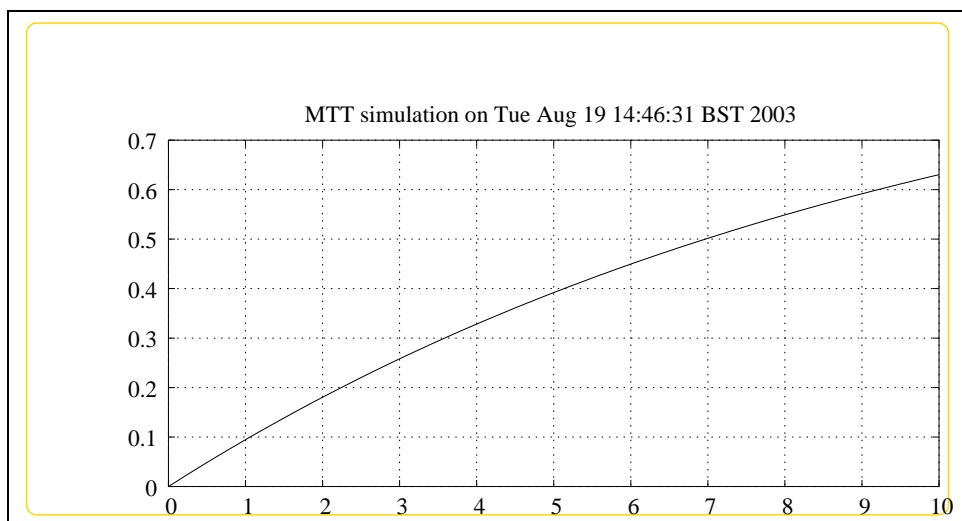

Figure 1.7: System **rc**, representation odeso (*-drstep-drr10*)

1.20 rc_numpar.txt (*-drpulse -drr10*)

MTT command:

```
mtt -dr pulse -dr r10 rc numpar txt
```

Tue Aug 19 14:47:25 BST 2003

Page 21.

```
## -*-octave-* - Put Emacs into octave-mode ##  
  
##  
## System rc, representation numpar, language txt;  
## File rc_numpar.txt;  
## Generated by MTT on Wed May 1 10:18:33 BST 2002;
```

```
c = 1.0; # c = 1 F  
r = 10.0; # r = 10 ohms
```

1.21 rc_input.txt (*-drpulse -drr10*)

MTT command:

```
mtt -dr pulse -dr r10 rc input txt
```

```
## -*-octave-* - Put Emacs into octave-mode ##  
  
##  
## System rc, representation input, language txt;  
## File rc_input.txt;  
## Generated by MTT on Wed May 1 08:47:22 BST 2002;
```

```
rc__e1 = 1.0*(t<1); # On for t<1
```

1.22 rc_odeso.ps (*-drpulse -drr10*)

MTT command:

```
mtt -dr pulse -dr r10 rc odeso ps
```

This representation is given as Figure 1.8 (on page 23).

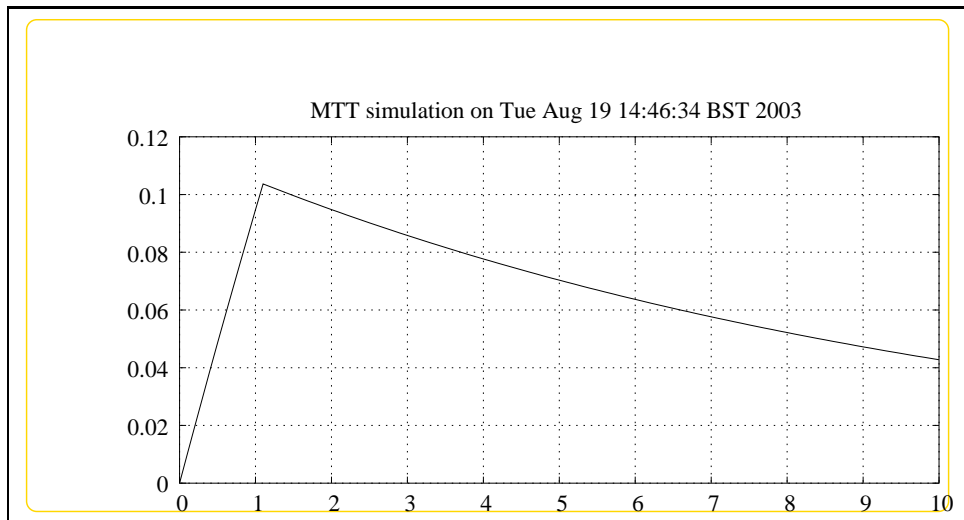
Figure 1.8: System **rc**, representation **odeso** (-drpulse-drr10)

1.23 rc_rep.txt

MTT command:

```
mtt rc rep txt
```

```
## -*-octave-* - Put Emacs into octave-mode
## Outline report file for system rc (rc_rep.txt)
## Generated by MTT on" Wed May 1 08:56:38 BST 2002.
```

```
#####
## Version control history
#####
## $Id: rc_rep.txt,v 1.2 2002/05/01 13:49:03 gawthrop Exp $
## $Log: rc_rep.txt,v $
## Revision 1.2 2002/05/01 13:49:03 gawthrop
## const --> step
##
## Revision 1.1 2000/12/28 11:58:07 peterg
## Put under RCS
##
#####
```

```
mtt rc abg tex # The system description
```

Tue Aug 19 14:47:25 BST 2003

Page 23.

```
mtt rc cbg ps          # The causal bond graph
mtt rc struc tex       # The system structure
mtt rc sympar txt      # The system parameters
## Uncomment the following lines or add others
## mtt rc dae tex      # The system dae
mtt rc ode tex # The system ode
## mtt rc sspar tex # Steady-state parameters
## mtt rc ss tex # Steady state
## mtt rc dm tex # Descriptor matrices (of linearised system)
mtt rc sm tex # State matrices (of linearised system)
mtt rc tf tex # Transfer function (of linearised system)
mtt rc lmfr ps # log modulus of frequency response (of linearised)
mtt rc simpar txt # Simulation parameters
## mtt rc state tex # Simulation initial state

## Default
mtt rc numpar txt # Numerical simulation parameters
mtt rc input txt # Simulation input
mtt rc odeso ps # Simulation output

## Step input
mtt -dr step rc input txt # Simulation input
mtt -dr step rc odeso ps # Simulation output

## Pulse input
mtt -dr pulse rc input txt # Simulation input
mtt -dr pulse rc odeso ps # Simulation output

## r = 10
## Step input
mtt -dr step -dr r10 rc numpar txt # Numerical simulation parameters
mtt -dr step -dr r10 rc input txt # Simulation input
mtt -dr step -dr r10 rc odeso ps # Simulation output

## Pulse input
mtt -dr pulse -dr r10 rc numpar txt # Numerical simulation parameters
mtt -dr pulse -dr r10 rc input txt # Simulation input
mtt -dr pulse -dr r10 rc odeso ps # Simulation output

mtt rc rep txt # This file
```

Chapter 2

rc2

2.1 rc2_abg.tex

MTT command:

```
mtt rc2 abg tex
```

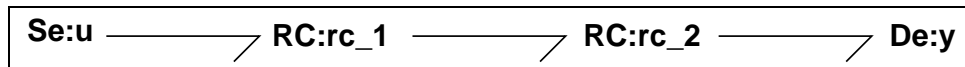

Figure 2.1: System **rc2**: acausal bond graph

The acausal bond graph of system **rc2** is displayed in Figure 2.1 (on page 25) and its label file is listed in Section 2.1.1 (on page 26). The subsystems are listed in Section 2.1.2 (on page 27).

This simple example illustrates the use of *hierarchical* bond graphs in MTT.

There are 4 subsystems:

Se:u An effort source providing the system input u .

RC:rc_1 An instance of the **RC** subsystem. In the label file for **rc2**, the parameters r_1 and c_1 are assigned to this subsystem.

RC:rc_2 An instance of the **RC** subsystem. In the label file for **rc2**, the parameters r_2 and c_2 are assigned to this subsystem.

De:y An effort detector providing the system output y .

2.1.1 Summary information

System rc2:Simple example of a heirarchical system Uses 2 copies of the RC subsystem

Interface information:

This component has no ALIAS declarations

Variable declarations:

This component has no PAR declarations

Units declarations:

This component has no UNITS declarations

The label file: rc2_lbl.txt

```
#SUMMARY rc2 Simple example of a heirarchical system
#DESCRIPTION Uses 2 copies of the RC subsystem
```

```
## System rc2, representation lbl, language txt
## File rc2_lbl.txt
## Generated by MTT on Thu Mar 13 16:27:26 GMT 2003
```

```
#####
##### Model Transformation Tools #####
#####
```

```
#####
## Version control history
#####
## $Id: rc2_lbl.txt,v 1.1 2003/03/13 16:34:40 gawthrop Exp $
## $Log: rc2_lbl.txt,v $
## Revision 1.1 2003/03/13 16:34:40 gawthrop
## New simple example of herachical rc circuit
##
## Revision 1.2 2001/07/03 22:59:10 gawthrop
## Fixed problems with argument passing for CRS
##
#####
```

```
## Each line should be of one of the following forms:
##      a comment (ie starting with #)
##      component-name cr_name arg1,arg2,..argn
##      blank

## ---- Component labels ----

## Component type De
y SS external

## Component type RC
rc_1 lin c_1;r_1
rc_2 lin c_2;r_2

## Component type Se
u SS external
```

2.1.2 Subsystems

- De Simple effort detector (1) No subsystems.
- RC A Simple two-port RC circuit (2) No subsystems.
- Se Simple effort source (1) No subsystems.

2.1.3 De

The acausal bond graph of system **De** is displayed in Figure 2.2 (on page 28) and its label file is listed in Section 2.1.3 (on page 27). The subsystems are listed in Section 2.1.3 (on page 29).

Summary information

System De:Simple effort detector Simple effort detector constructed from SS with fixed causality

Interface information:

Parameter \$1 represents actual parameter **external**

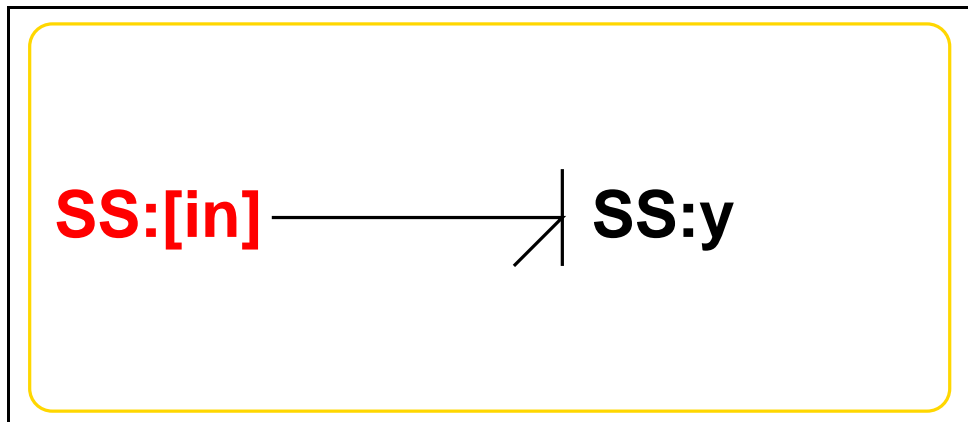
Figure 2.2: System **De**: acausal bond graph

Port in represents actual port **in**

Port out represents actual port **in**

Variable declarations:

This component has no PAR declarations

Units declarations:

This component has no UNITS declarations

The label file: **De_lbl.txt**

```

%% Label file for system De (De_lbl.txt)
%SUMMARY De Simple effort detector
%DESCRIPTION Simple effort detector constructed from SS with fixed

% %%%%%%%%%%%
% %% Version control history
% %%%%%%%%%%%
% %% $Id: De_lbl.txt,v 1.4 2002/11/07 04:28:23 gawthrop Exp $
% %% $Log: De_lbl.txt,v $
% %% Revision 1.4 2002/11/07 04:28:23 gawthrop
% %% Now has argument - either internal or external
% %%
% %% Revision 1.3 1999/09/07 03:32:21 peterg

```

```

% %% Fixed alias bug
% %%
% %% Revision 1.2 1999/09/07 03:21:02 peterg
% %% Aliased to out as well as in
% %%
% %% Revision 1.1 1999/03/03 22:02:04 peterg
% %% Initial revision
% %%
% %%%%%%%%%%%%%%%%%%%%%%%%%%%%%%%%%%%%%%%%%%%%%%%%%%%%%%%%%%%%%%%%%%%%%%%%%

% Port aliases
%ALIAS in|out in

% Argument aliases
%ALIAS $1 external

%% Each line should be of one of the following forms:
%     a comment (ie starting with %)
%     component-name cr_name arg1,arg2,..argn
%     blank

% ---- Component labels ----

% Component type SS
[in] SS external,external
y SS external,0

```

Subsystems

No subsystems.

2.1.4 RC

RC is a Simple two-port RC circuit. The two ports are [in] and [out] and the two parameters are c and r respectively

The acausal bond graph of system **RC** is displayed in Figure 2.3 (on page 30) and its label file is listed in Section 2.1.4 (on page 30). The subsystems are listed in Section 2.1.4 (on page 32).

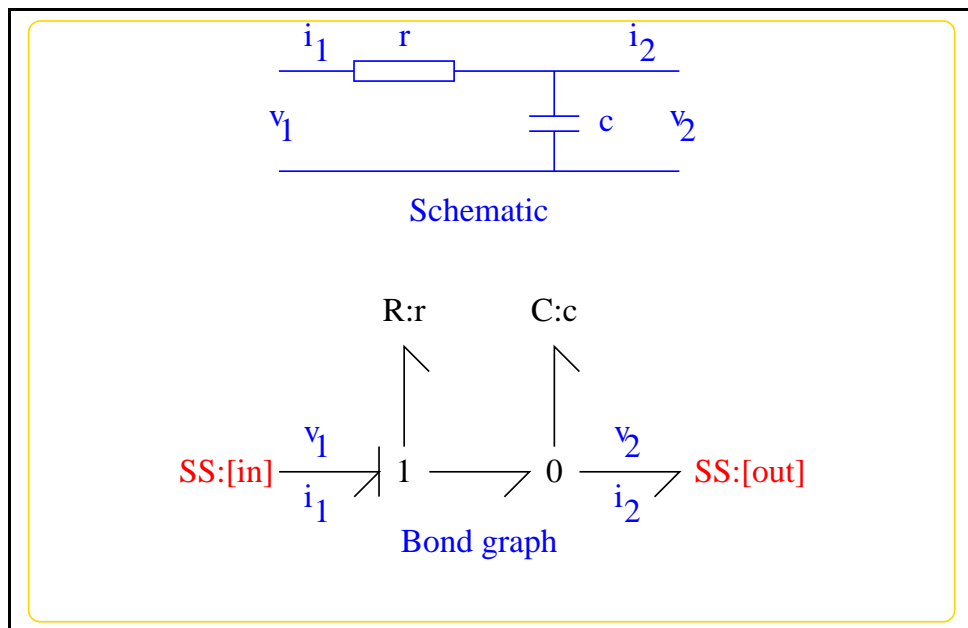
Figure 2.3: System **RC**: acausal bond graph**Summary information**

System RC:A Simple two-port RC circuit This simple example is used in the manual.

Interface information:

Parameter \$1 represents actual parameter **c** – Capacitance

Parameter \$2 represents actual parameter **r** – Resistance

Port in represents actual port **in** – The left-hand port

Port out represents actual port **out** – The right-hand port

Variable declarations:

This component has no PAR declarations

Units declarations:

This component has no UNITs declarations

The label file: RC_lbl.txt

```

%% Label file for system RC (RC_lbl.txt)
%SUMMARY RC A Simple two-port RC circuit
%DESCRIPTION This simple example is used in the manual.

% %%%%%%%%%%%%%%%%%%%%%%%%%%%%%%%%%%%%%%%%%%%%%%%%%%%%%%%%%%%%%%%%%%%%%%%%%
% %% Version control history
% %%%%%%%%%%%%%%%%%%%%%%%%%%%%%%%%%%%%%%%%%%%%%%%%%%%%%%%%%%%%%%%%%%%%%%%%%
% %% $Id: RC_lbl.txt,v 1.4 2001/07/24 04:25:16 gawthrop Exp $
% %% $Log: RC_lbl.txt,v $
% %% Revision 1.4 2001/07/24 04:25:16 gawthrop
% %% Relabeled ports - easier for sensitivity to handle
% %%
% %% Revision 1.3 2000/09/14 15:13:02 peterg
% %% Changed port CRs to give SISO system when used in isolation
% %%
% %% Revision 1.2 1998/07/27 11:09:36 peterg
% %% Commented the aliases.
% %%
% %% Revision 1.1 1998/07/16 20:16:30 peterg
% %% Initial revision
% %%
% %%%%%%%%%%%%%%%%%%%%%%%%%%%%%%%%%%%%%%%%%%%%%%%%%%%%%%%%%%%%%%%%%%%%%%%%%

% Port aliases
%ALIAS in in # The left-hand port
%ALIAS out out # The right-hand port

% Argument aliases
%ALIAS $1 c # Capacitance
%ALIAS $2 r # Resistance

%% Each line should be of one of the following forms:
%      a comment (ie starting with %)
%      component-name cr_name arg1,arg2,..argn
%      blank

% ---- Component labels ----

```

```
% Component type C
c lin effort,c

% Component type R
r lin flow,r

% Component type SS
[in] SS external,internal
[out] SS external,0
```

Subsystems

No subsystems.

2.1.5 Se

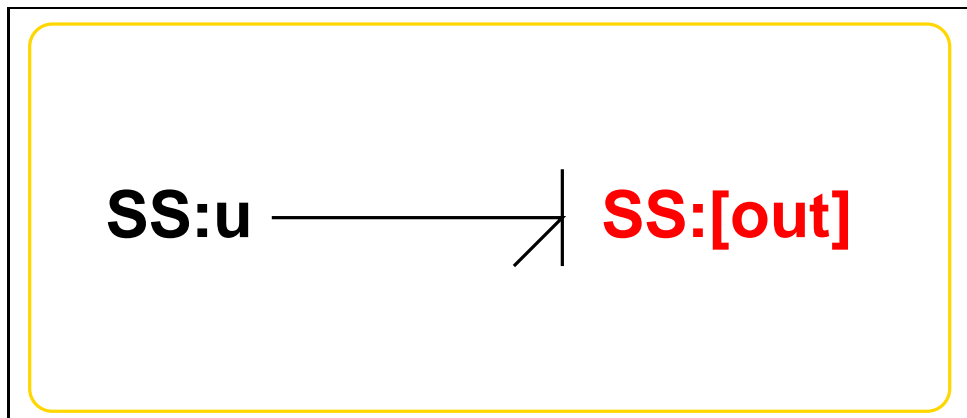

Figure 2.4: System **Se**: acausal bond graph

The acausal bond graph of system **Se** is displayed in Figure 2.4 (on page 32) and its label file is listed in Section 2.1.5 (on page 32). The subsystems are listed in Section 2.1.5 (on page 34).

Summary information

System Se:Simple effort source Simple effort source constructed from SS with fixed causality

Interface information:

Parameter \$1 represents actual parameter **e_s**

Port in represents actual port **out**

Port out represents actual port **out**

Variable declarations:

This component has no PAR declarations

Units declarations:

This component has no UNITs declarations

The label file: Se_lbl.txt

```

%% Label file for system Se (Se_lbl.txt)
%SUMMARY Se Simple effort source
%DESCRIPTION Simple effort source constructed from SS with fixed causali

% %%%%%%%%%%%%%%%%%%%%%%%%%%%%%%%%%%%%%%%%%%%%%%%%%%%%%%%%%%
% %% Version control history
% %%%%%%%%%%%%%%%%%%%%%%%%%%%%%%%%%%%%%%%%%%%%%%%%%%%%%%%%%%
% %% $Id: Se_lbl.txt,v 1.3 1999/08/05 07:31:39 peterg Exp $
% %% $Log: Se_lbl.txt,v $
% %% Revision 1.3 1999/08/05 07:31:39 peterg
% %% Added in alias
% %%
% %% Revision 1.2 1999/03/12 04:04:27 peterg
% %% Single argument - the effort value e_s
% %%
% %% Revision 1.1 1999/03/03 21:55:46 peterg
% %% Initial revision
% %%
% %%%%%%%%%%%%%%%%%%%%%%%%%%%%%%%%%%%%%%%%%%%%%%%%%%%%%%%%%%

% Port aliases
%ALIAS out|in out

```

```

% Argument aliases
%ALIAS $1 e_s

%% Each line should be of one of the following forms:
%      a comment (ie starting with %)
%      component-name cr_name arg1,arg2,..argn
%      blank

% ---- Component labels ----

% Component type SS
[out] SS external,external
u SS e_s,internal

```

Subsystems

No subsystems.

2.2 rc2_cbg.ps

MTT command:

```
mtt rc2 cbg ps
```

This representation is given as Figure 2.5 (on page 34).

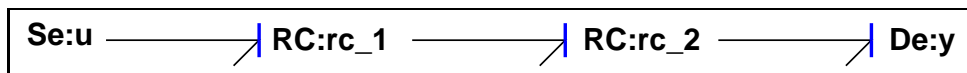

Figure 2.5: System **rc2**, representation **cbg** (-noargs)

2.3 rc2_struct.tex

MTT command:

```
mtt rc2 struc tex
```

List of inputs for system rc2			
	Component	System	Repetition
1	u	rc2__u__u	1

List of outputs for system rc2			
	Component	System	Repetition
1	y	rc2__y__y	1

List of states for system rc2			
	Component	System	Repetition
1	c	rc2__rc_1__c	1
2	c	rc2__rc_2__c	1

2.4 rc2_sympar.tex

MTT command:

```
mtt rc2 sympar tex
```

Parameter	System
c_1	rc2
c_2	rc2
r_1	rc2
r_2	rc2

Table 2.1: Parameters

2.5 rc2_ode.tex

MTT command:

```
mtt rc2 ode tex
```

$$\begin{aligned}\dot{x}_1 &= \frac{(c_1 c_2 u_1 r_2 + c_1 x_2 r_1 - c_2 x_1 r_1 - c_2 x_1 r_2)}{(c_1 c_2 r_1 r_2)} \\ \dot{x}_2 &= \frac{(-c_1 x_2 + c_2 x_1)}{(c_1 c_2 r_2)}\end{aligned}\tag{2.1}$$

$$y_1 = \frac{x_2}{c_2}\tag{2.2}$$

2.6 rc2_sm.tex

MTT command:

```
mtt rc2 sm tex
```

$$A = \begin{pmatrix} \frac{-(r_1+r_2)}{(c_1 r_1 r_2)} & \frac{1}{(c_2 r_2)} \\ \frac{1}{(c_1 r_2)} & \frac{(-1)}{(c_2 r_2)} \end{pmatrix}\tag{2.3}$$

$$B = \begin{pmatrix} \frac{1}{r_1} \\ 0 \end{pmatrix}\tag{2.4}$$

$$C = \left(0 \quad \frac{1}{c_2} \right)\tag{2.5}$$

$$D = (0)\tag{2.6}$$

2.7 rc2_tf.tex

MTT command:

```
mtt rc2 tf tex
```

$$G = \left(\frac{1}{(c_1 c_2 r_1 r_2 s^2 + c_1 r_1 s + c_2 r_1 s + c_2 r_2 s + 1)} \right)\tag{2.7}$$

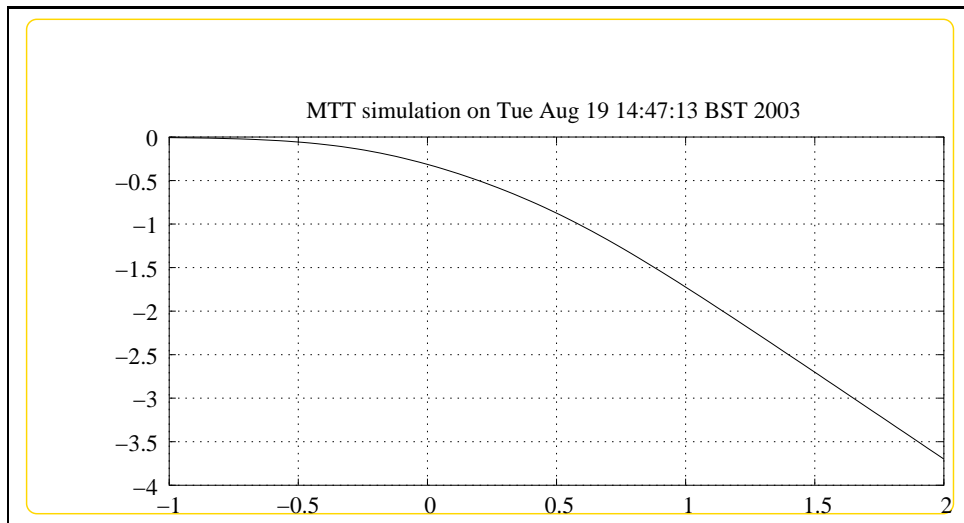

Figure 2.6: System **rc2**, representation **lmfr** (-noargs)

2.8 rc2_lmfr.ps

MTT command:

```
mtt rc2 lmfr ps
```

This representation is given as Figure 2.6 (on page 37).

2.9 rc2_numpar.txt

MTT command:

```
mtt rc2 numpar txt
```

```
## --octave-- Put Emacs into octave-mode ##
```

```
##
```

```
## System rc2, representation numpar, language txt;
```

```
## File rc2_numpar.txt;
```

```
## Generated by MTT on Thu Jun 5 14:58:43 BST 2003;
```

```
c_1 = 1.0;
```

Tue Aug 19 14:47:25 BST 2003

Page 37.

```
c_2 = 0.5;  
r_1 = 1.0;  
r_2 = 1.0;
```

2.10 rc2_odeso.ps

MTT command:

```
mtt rc2 odeso ps
```

This representation is given as Figure 2.7 (on page 38).

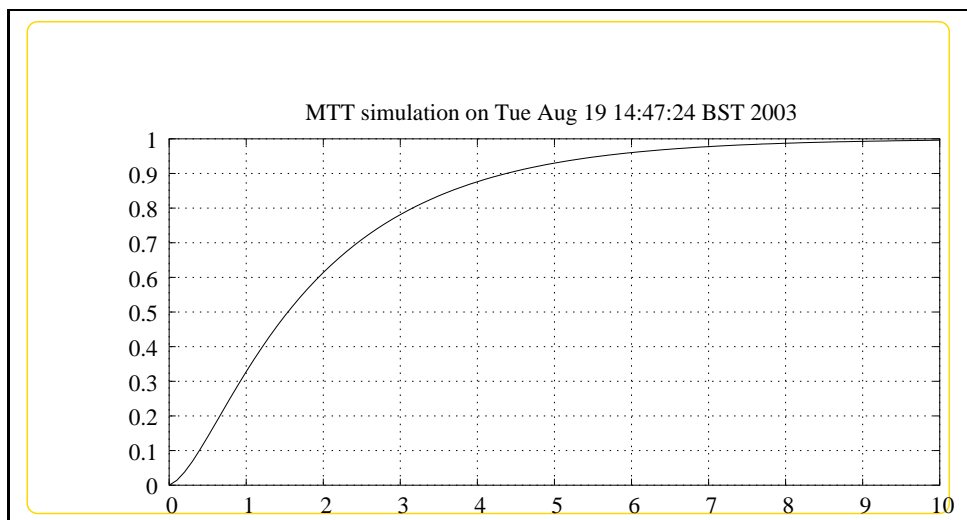

Figure 2.7: System **rc2**, representation odeso (-noargs)

2.11 rc2_rep.txt

MTT command:

```
mtt rc2 rep txt
```

```
## -*-octave-*  
## Put Emacs into octave-mode  
## Outline report file for system rc2 (rc2_rep.txt)  
## Generated by MTT on" Mon Mar 24 17:01:52 GMT 2003.
```

```
#####  
## Version control history  
#####  
## $Id: rcs_header.sh,v 1.1 2000/12/28 11:58:07 peterg Exp $  
## $Log: rcs_header.sh,v $  
## Revision 1.1 2000/12/28 11:58:07 peterg  
## Put under RCS  
##  
#####  
  
mtt rc2 abg tex # The system description  
mtt rc2 cbg ps # The causal bond graph  
mtt rc2 struc tex # The system structure  
mtt rc2 sympar tex # The system parameters  
## Uncomment the following lines or add others  
## mtt rc2 dae tex # The system dae  
mtt rc2 ode tex # The system ode  
## mtt rc2 sspar tex # Steady-state parameters  
## mtt rc2 ss tex # Steady state  
## mtt rc2 dm tex # Descriptor matrices (of linearised system)  
mtt rc2 sm tex # State matrices (of linearised system)  
mtt rc2 tf tex # Transfer function (of linearised system)  
mtt rc2 lmfr ps # log modulus of frequency response (of linear  
## mtt rc2 simpar txt # Simulation parameters  
mtt rc2 numpar txt # Numerical simulation parameters  
## mtt rc2 state txt # Simulation initial state  
## mtt rc2 input txt # Simulation input  
## mtt rc2 logic txt # Logic control  
mtt rc2 odeso ps # Simulation output  
  
mtt rc2 rep txt # This file
```

Index

- De** – abg, 27
 - De** – lbl, 27
- De** – subsystems, 29
 - RC** – abg, 29
 - RC** – lbl, 30
- RC** – subsystems, 32
 - Se** – abg, 32
 - Se** – lbl, 32
- Se** – subsystems, 34
 - rc2** – abg, 25
 - rc2** – cbg, 34
 - rc2** – lbl, 26
 - rc2** – lmfr, 37
 - rc2** – numpar, 37
 - rc2** – ode, 35
 - rc2** – odeso, 38
 - rc2** – rep, 38
 - rc2** – sm, 36
 - rc2** – struc, 34
- rc2** – subsystems, 27
 - rc2** – sympar, 35
 - rc2** – tf, 36
 - rc** – abg, 9
 - rc** – cbg, 12
- rc** – input, 17, 18, 20, 22
 - rc** – lbl, 9
 - rc** – lmfr, 15
- rc** – numpar, 16, 19, 21
 - rc** – ode, 14
- rc** – odeso, 17–19, 21, 22
 - rc** – rep, 23
 - rc** – simpar, 15
 - rc** – sm, 14
 - rc** – struc, 12
- rc** – subsystems, 12
 - rc** – sympar, 14
 - rc** – tf, 15